

User Manual

Series SM

English. 2

Thank you for choosing AVEL TV! Before using and installing the product, please read this guide.

Please keep this manual for future reference.

The information in this manual is subject to change without prior notice.



Warnings

To reduce the risk of fire, electric shock and other injuries, keep these safety precautions in mind when installing, using and maintaining your TV. The mains outlet should be installed near the equipment, be easily accessible. The TV should be connected to a grounded GFCI protected mains outlet.

- To protect against electric shock, do not immerse the power cord, power plug or product in water or other liquid.
- Do not overload AC outlets or extension cords. Overloading can cause a fire.
- Close supervision by adults is necessary when a product is used by or near children.
- Do not operate the product with a damaged cord or plug or if it has been damaged in any manner.
- Do not let the power cord get in contact with hot surfaces.
- If you notice any smoke or scorched smell near the product, unplug the power cord and contact qualified personnel for service or repair.
- Do not use or place any combustible or flammable substances near the product.
- Do not use this product for other than intended use.
- This product is intended for indoor use only.
- For added safety, during a light storm, or when this product is left unattended and unused for a long time, unplug it from the wall outlet and disconnect the antenna.
- Do not use detergents containing abrasives.

Accessories

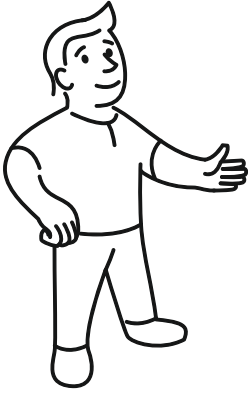

Please make sure that the accessories are in the package as shown below:

1. Mounting back box x 1 pcs.
2. Mounting bolts set x 1 pcs.
3. Installation manual x 1 pcs.
4. Installation drawing x 1 pcs.
5. Warranty service card x 1 pcs.
6. Remote control x 2 pcs.
7. Power cable x 1 pcs.
8. Power adapter x 1 pcs.**
9. Waterproof remote control holder x 1 pcs.
10. User manual x 1 pcs.

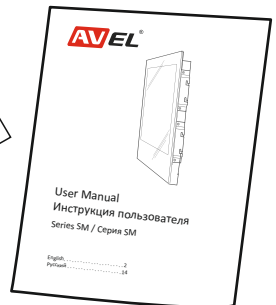
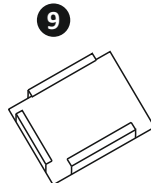
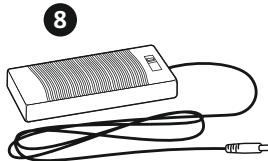
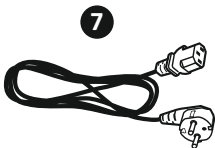
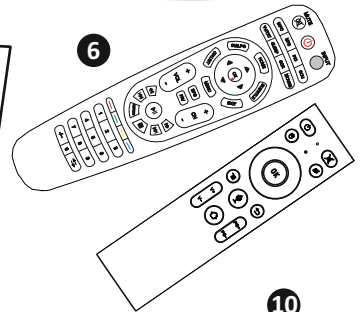
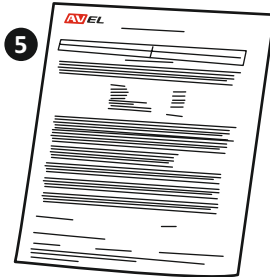
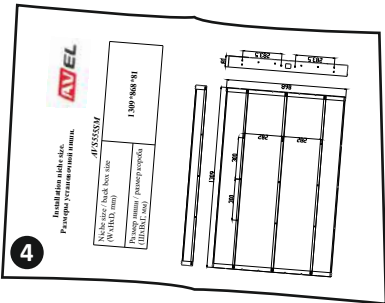
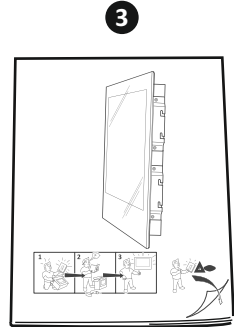
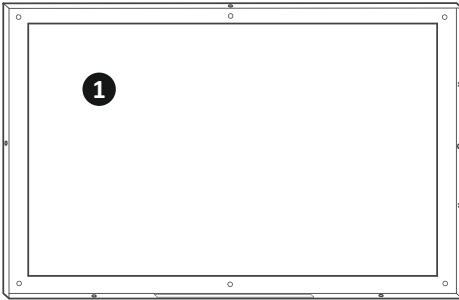

* Image is given for reference and may be different with the actual components.

** Only 23.8"-55" TV.

*** Mounting black box might have a different look depending on the model.

Remote control

On / Off sound

Power On / Off

Information

Broadcast language

Teletext

Designates power off after a specified time

Teletext subpage switching

Displays channels list

Displays available EPG (Electronic Program Guide)

Channel selection

Picture formats

According to the menu options

Input source menu

Configures sound presets

Configures ratio and appearance of picture

Cursor On / Off

Screenshot

Smart TV

Subtitle management

To close the On Screen Display Menu

Use arrows and OK to navigate menu

On Screen Display menu / Go back

Favorite channels list

Volume level selection

Media player control buttons

Channel selection block

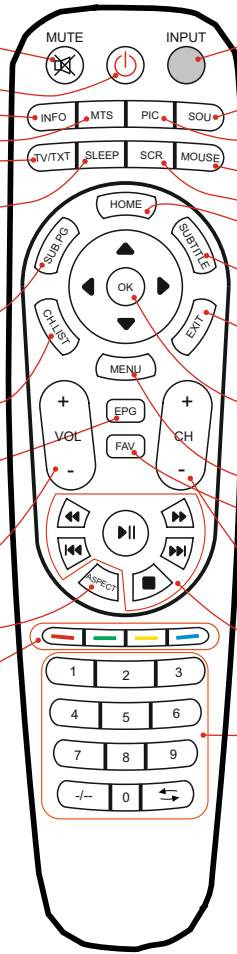

Battery replacement

Battery type AAA



x 2

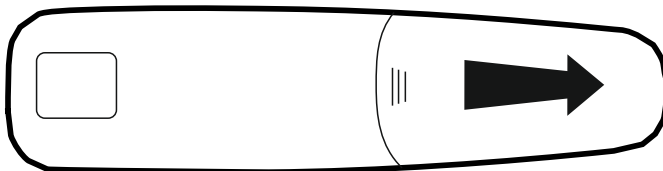

Bluetooth remote control for Smart TV

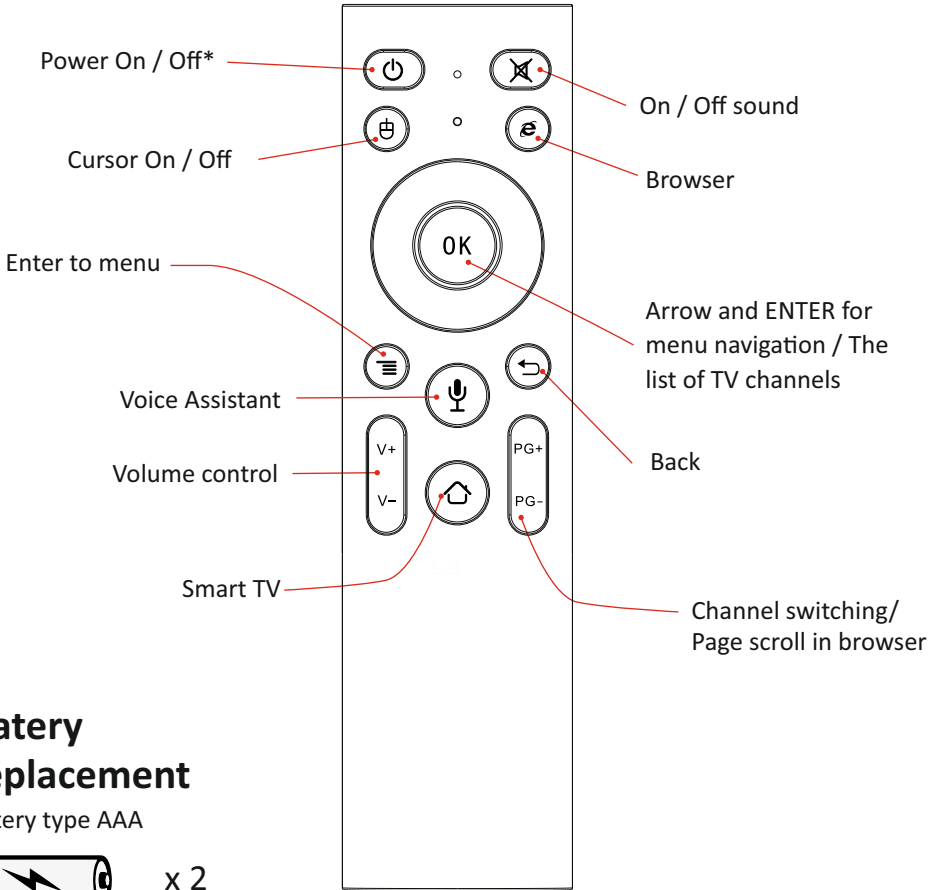

Battery replacement

Battery type AAA



*You can teach the Power button from the original remote control. 1) Hold the Power for 3 sec (you can see the red blinking indication on the smartremote). 2) Line up smart remote and original remote head-to-head. 3) Push a button on the original remote.

**Before using the remote control you should connect it to the TV. For connecting push and hold the buttons "V-" and "PG-" till red indicator on the RC become blinking. Then go to the BT settings on the TV and pair to the HBG_RC device.

***For calibration Airmouse push and hold buttons "OK" and "HOME" till indicator is on. Then put the remote control on the flat horizontal surface for 3 seconds. Once the red indicator is off you can use the RC.

Inputs and Outputs

23,8"

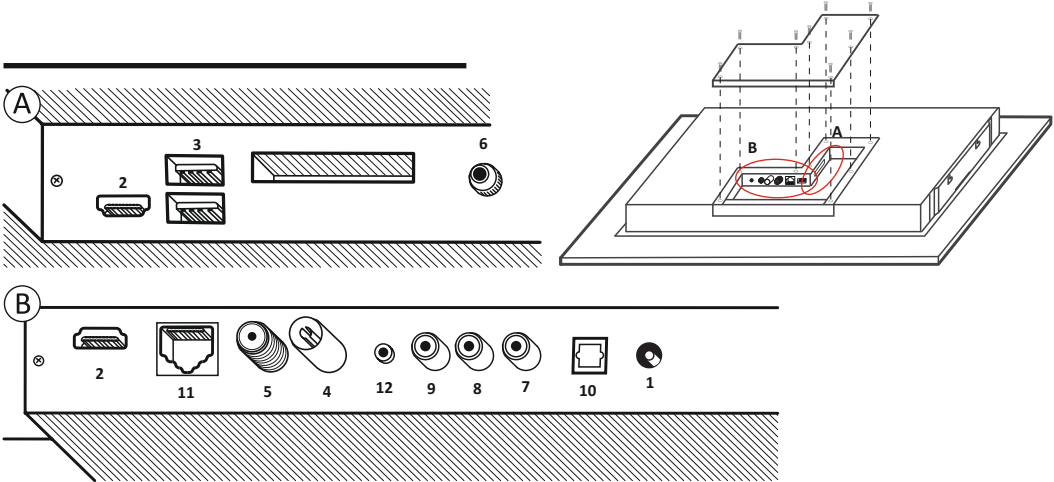

Power x 1

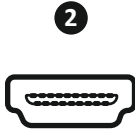

HDMI input x 2



USB-port x 2



TV x 1



TV(S2) x1



IR control x 1*



Video IN x 1



Audio L x 1



Audio R x 1



Optical Audio Out x 1



Rj45 x 1



Headphones x 1

* For external IR receiver or IR pass through connector.

Inputs and Outputs

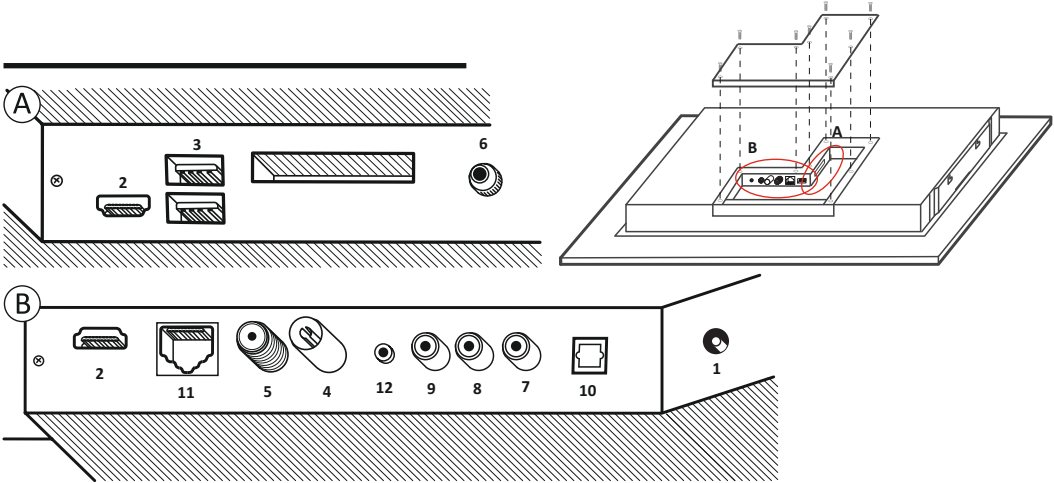
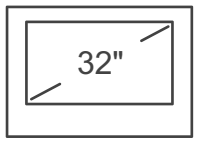

Power x 1

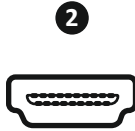

HDMI input x 2



USB-port x 2



TV x 1



TV(S2) x1



IR control x 1*



Video IN x 1



Audio L x 1



Audio R x 1



Optical Audio Out x 1



Rj45 x 1



Headphones x 1

* For external IR receiver or IR pass through connecton.

Inputs and Outputs

43"-55"

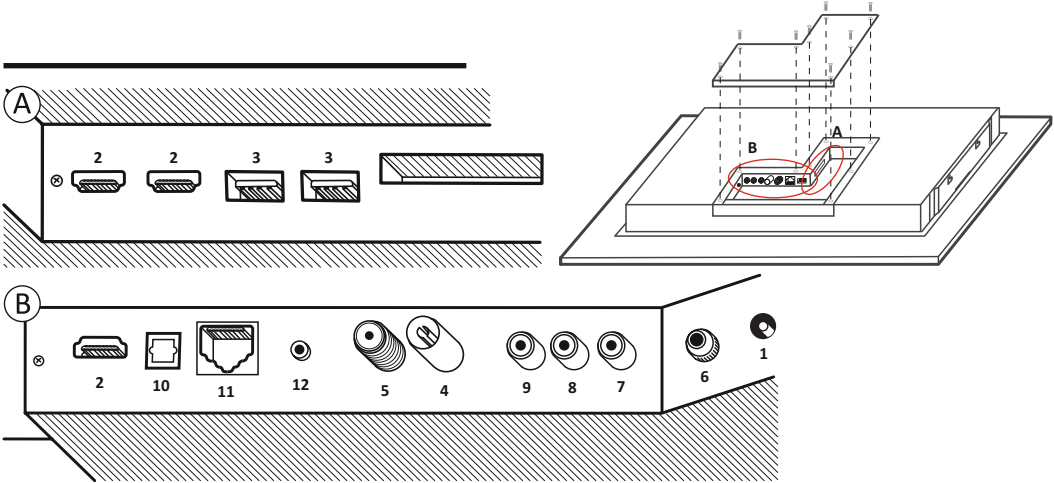

Power x 1

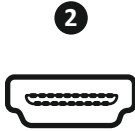

HDMI input x 3



USB-port x 2



TV x 1



TV(S2) x 1



IR control x 1*



Video IN x 1



Audio L x 1



Audio R x 1



Optical Audio Out x 1



Rj45 x 1











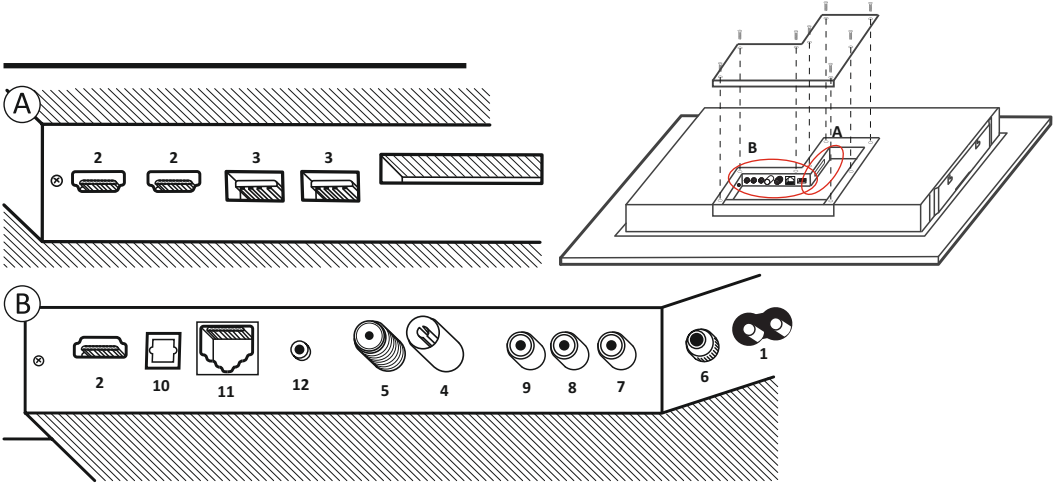

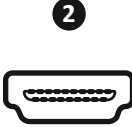

Headphones x 1

* For external IR receiver or IR pass through connector.

Inputs and Outputs

65"-75"



- | | | | | |
|--|--|--|---|---|
| 
1 | 
2 | 
3 | 
4 | |
| Power x 1 | HDMI input x 3 | USB-port x 2 | TV x 1 | |
| 
5 | 
6 | 
7 | 
8 | 
9 |
| TV(S2) x 1 | IR control x 1* | Video IN x 1 | Audio L x 1 | Audio R x 1 |
| 
10 | 
11 | 
12 | | |
| Optical Audio Out x 1 | Rj45 x 1 | Headphones x 1 | | |

* For external IR receiver or IR pass through connector.

Settings



Source settings

1. Push the button SOURCE.
2. Choose in the menu by buttons ARROW UP/DOWN the source you need.
3. Push the ENTER for confirming.
4. Push button MENU for returning channel settings.

Quick Menu

Choose any source (except Smart TV), press MENU to go to common settings.

Image settings

Use for changing brightness, color, noise reduction, and color temperature.

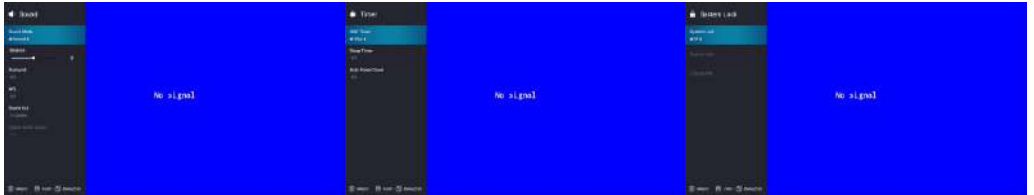

Sound settings

Use for equalizer settings, automatic volume control, and surround sound effect.

Timer settings

Use for timer settings and automatic switching off the TV.

Security settings

Use for passwords settings and block the sources.



Menu settings

Use for additional settings and reset mode.

CEC settings

HDMI CEC allows controlling the unit by HDMI.



SMART TV



Smart TV launch

For launching Smart TV press the button  on the remote control.



Settings

In the settings menu, you can connect to the Wi-Fi, change the language, apps parameters, set the date and time and etc.



Network settings

Use for wireless and wire networks, for connecting the accessories by Bluetooth.



Time settings

Use for settings time, date and time zone.



Common settings

Use for settings language, desktop picture, for apps control and other Smart TV parameters.



About device

Use for checking information about the device.

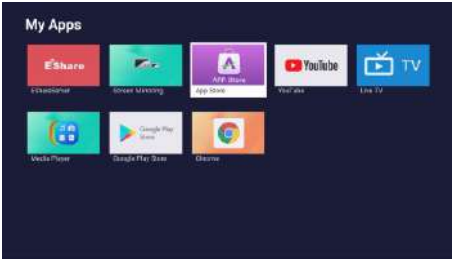

My APPS

Use for launch installed apps.

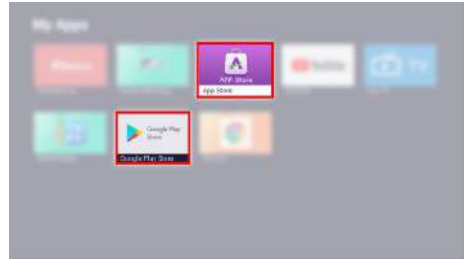

Apps installation

You can use App Store or Google Play store for the installation of new Apps.

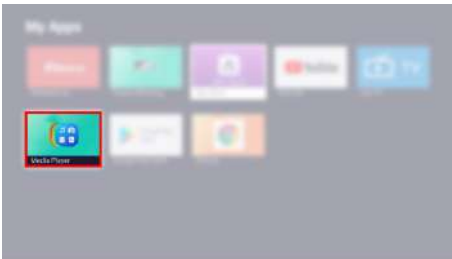

Playing files from USB memory card

For playing content from USB card launch Mediaplayer.

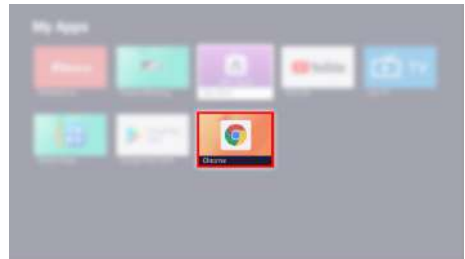

Searching the web pages

For searching web pages use Google Chrome browser.



Screen Mirroring

For connecting Android devices to the TV launch Screen Mirroring.



Returning to the TV mode

For returning to the TV settings, please launch Live TV app.

Panel buttons*



⊕ M V- V+ CH- CH+ ■
1 2 3 3 4 4 5

- ❶ Power On/Off
- ❷ On Screen Display menu
- ❸ Volume level selection
- ❹ Channel selection
- ❺ Input source menu

Troubleshooting



Symptoms

Blank screen



Possible Solution

Check the LED indicator. If the LED indicator is red, the TV is in standby. If the LED indicator is green, try to change input/source. If the LED indicator is black, check the power connection and LED indicator at power adapter.

Remote control doesn't work

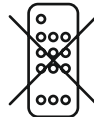

Point the remote control to the TV and press power button on the remote control. If the status LED becomes green, remote control is OK. If not, replace the batteries of the remote control.

* Option, not available for Mirror TVs.



AVIS ELECTRONICS OVERSEAS LIMITED

Manufacturer: 506-507A, HuiGu ChuangXin Technology park, JingBei road, Shiyan town , Baoan district, Shenzhen, Guangdong, China, 518108

For more details, please visit www.aviselectronics.tech

Manufacturer's legal address: 506-507A, HuiGu ChuangXin Technology park, JingBei road, Shiyan town , Baoan district, Shenzhen, Guangdong, China, 518108

Importer: ILVIPL Sp.z.o.o

Adres prawny importera: 50-541 Wrocław, Aleja Armii Krajowej, 45

Więcej informacji na stronie www.aviselectronics.pl

Made in China | Wyprodukowano w Chinach

